

## Features

- Full Power at Wide Output Current Range (Constant Power)
- Adjustable Output Current (AOC) with Programmability
- Isolated 0-10V/PWM/3-Timer-Modes Dimmable
- INV Digital Dimming, UART Based Communication Protocol
- Dim-to-Off with Standby Power  $\leq 0.5$  W
- Always-on Auxiliary Power:  
12Vdc, 250mA, 3W (Transient Peak Power up to 10W)
- Output Lumen Compensation
- End-of-Life Indicator
- Input Surge Protection: DM 6kV, CM 10kV
- All-Around Protection: IUVP, IOVP, OVP, SCP, OTP
- IP66 / IP67 and UL Dry / Damp / Wet Location
- TYPE HL, for Use in a Class I, Division 2 Hazardous (Classified) Location
- 5 Years Warranty



## Description

The EUM-200SxxxMx series is a 200W, constant-current, programmable and IP66/IP67 rated LED driver that operates from 90-305Vac input with excellent power factor. Created for smart lighting application, this family provides an auxiliary voltage and dim-to-off functionality for powering low voltage, wireless controls. The dimming control supports 0-10V dimming as well as two-way communication via Digital Dimming, a UART based communication protocol. The high efficiency of these drivers and compact metal case enables them to run cooler, significantly improving reliability and extending product life. To ensure trouble-free operation, protection is provided against input surge, input under voltage, input over voltage, output over voltage, short circuit, and over temperature.

## Models

Adjustable Output Current Range	Full-Power Current Range(1)	Default Output Current	Input Voltage Range(2)	Output Voltage Range	Max. Output Power	Typical Efficiency (3)	Typical Power Factor		Model Number (5)
							120Vac	220Vac	
70-1050mA	700-1050mA	700 mA	90~305 Vac/ 127~300 Vdc	95~286 Vdc	200 W	93.5%	0.99	0.96	EUM-200S105Mx
105-1500mA	1050-1500mA	1050 mA	90~305 Vac/ 127~300 Vdc	67~190 Vdc	200 W	93.5%	0.99	0.96	EUM-200S150Mx
180-2800mA	1800-2800mA	2100 mA	90~305 Vac/ 127~300 Vdc	36~111 Vdc	200 W	93.0%	0.99	0.96	EUM-200S280Mx <sup>(4)</sup>
350-5600mA	3500-5600mA	4200 mA	90~305 Vac/ 127~300 Vdc	18 ~ 57 Vdc	200 W	92.0%	0.99	0.96	EUM-200S560Mx <sup>(4)</sup>

- Notes:** (1) Output current range with constant power at 200W  
 (2) Certified input voltage range: UL, FCC 100-277Vac; otherwise 100-240Vac.  
 (3) Measured at 100% load and 220Vac input (see below "General Specifications" for details).  
 (4) SELV output.  
 (5) x = G are UL Recognized, ENEC and CCC, etc. models; x = T are UL Class P models.

## I-V Operation Area

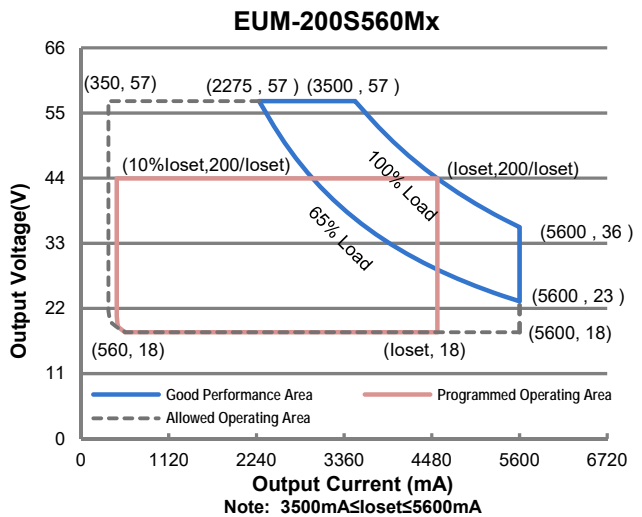
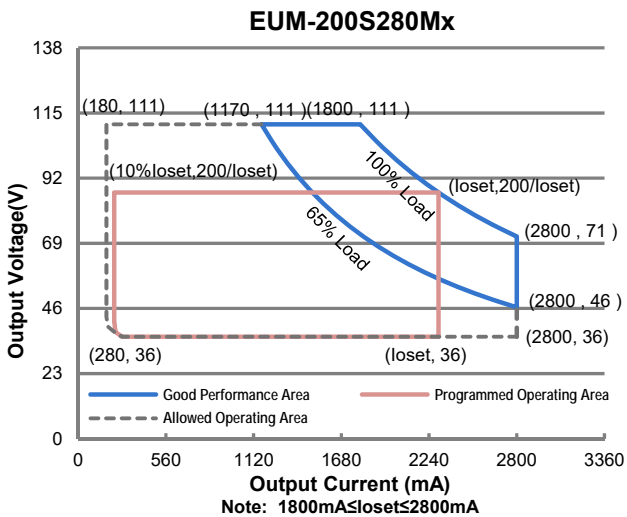
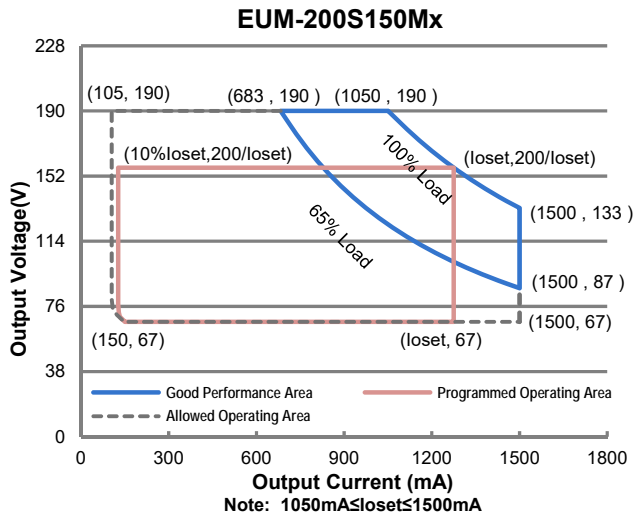
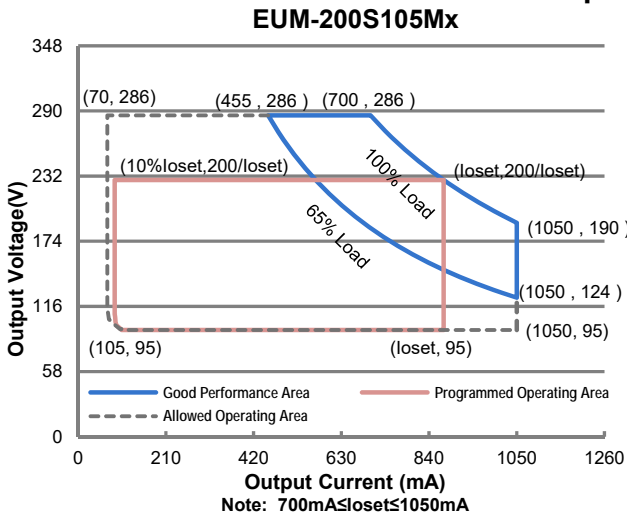

## Input Specifications

Parameter	Min.	Typ.	Max.	Notes
Input AC Voltage	90 Vac	-	305 Vac	
Input DC Voltage	127 Vdc	-	300 Vdc	
Input Frequency	47 Hz	-	63 Hz	
Leakage Current	-	-	0.75 MIU	UL8750; 277Vac/ 60Hz
	-	-	0.70 mA	IEC60598-1; 240Vac/ 60Hz,
Input AC Current	-	-	2.07 A	Measured at 100% load and 120 Vac input.
	-	-	1.1 A	Measured at 100% load and 220 Vac input.
Inrush Current(I <sup>2</sup> t)	-	-	4.61 A <sup>2</sup> s	At 220Vac input, 25°C cold start, duration=776 μs, 10%I <sub>pk</sub> -10%I <sub>pk</sub> . See Inrush Current Waveform for the details.

## Input Specifications (Continued)

Parameter	Min.	Typ.	Max.	Notes
PF	0.9	-	-	At 100-277Vac, 50-60Hz, 65%-100% load (130-200W)
THD	-	-	20%	At 100-277Vac, 50-60Hz, 65%-100% load (130-200W)
THD	-	-	10%	At 220-240Vac, 50-60Hz, 75%-100% load (150-200W)

## Output Specifications

Parameter	Min.	Typ.	Max.	Notes
Output Current Tolerance	-5%loset	-	5%loset	At 100% load condition
Output Current Setting(loset) Range				
EUM-200S105Mx	70 mA	-	1050 mA	
EUM-200S150Mx	105 mA	-	1500 mA	
EUM-200S280Mx	180 mA	-	2800 mA	
EUM-200S560Mx	350 mA	-	5600 mA	
Output Current Setting Range with Constant Power				
EUM-200S105Mx	700 mA	-	1050 mA	
EUM-200S150Mx	1050 mA	-	1500 mA	
EUM-200S280Mx	1800 mA	-	2800 mA	
EUM-200S560Mx	3500 mA	-	5600 mA	
Total Output Current Ripple (pk-pk)	-	5%lomax	10%lomax	At 100% load condition. 20 MHz BW
Output Current Ripple at < 200 Hz (pk-pk)	-	2%lomax	-	At 100% load condition. Only this component of ripple is associated with visible flicker.
Startup Overshoot Current	-	-	10%lomax	At 100% load condition
No Load Output Voltage				
EUM-200S105Mx	-	-	360 V	
EUM-200S150Mx	-	-	240 V	
EUM-200S280Mx	-	-	120 V	
EUM-200S560Mx	-	-	75 V	
Line Regulation	-	-	±0.5%	Measured at 100% load
Load Regulation	-	-	±3.0%	
Turn-on Delay Time	-	-	0.5 s	Measured at 120-277Vac input, 65%-100%load
Temperature Coefficient of loset	-	0.03%/°C	-	Case temperature = 0°C ~Tc max
12V Auxiliary Output Voltage	10.8 V	12 V	13.2 V	
12V Auxiliary Output Source Current	0 mA	-	250 mA	Return terminal is "Dim"
12V Auxiliary Output Transient Peak Current@6W	-	-	500 mA	500mA peak for a maximum duration of 2.2ms in a 6.0ms period during which time the average should not exceed 250mA.
12V Auxiliary Output Transient Peak Current@10W	-	-	850 mA	850mA peak for a maximum duration of 1.3ms in a 5.2ms period during which time the average should not exceed 250mA.

## General Specifications

Parameter	Min.	Typ.	Max.	Notes
Efficiency at 120 Vac input: EUM-200S105Mx				Measured at 100% load and steady-state temperature in 25°C ambient; (Efficiency will be about 2.0% lower if measured immediately after startup.)
Io= 700 mA	88.5%	90.5%	-	
Io=1050 mA	89.0%	91.0%	-	
EUM-200S150Mx				
Io=1050 mA	88.5%	90.5%	-	
Io=1500 mA	88.5%	90.5%	-	
EUM-200S280Mx				
Io=1800 mA	88.0%	90.0%	-	
Io=2800 mA	88.0%	90.0%	-	
EUM-200S560Mx				
Io=3500 mA	87.0%	89.0%	-	
Io=5600 mA	87.0%	89.0%	-	
Efficiency at 220 Vac input: EUM-200S105Mx				Measured at 100% load and steady-state temperature in 25°C ambient; (Efficiency will be about 2.0% lower if measured immediately after startup.)
Io= 700 mA	91.5%	93.5%	-	
Io=1050 mA	91.5%	93.5%	-	
EUM-200S150Mx				
Io=1050 mA	91.5%	93.5%	-	
Io=1500 mA	91.5%	93.5%	-	
EUM-200S280Mx				
Io=1800 mA	91.0%	93.0%	-	
Io=2800 mA	91.0%	93.0%	-	
EUM-200S560Mx				
Io=3500 mA	90.0%	92.0%	-	
Io=5600 mA	89.5%	91.5%	-	
Efficiency at 277 Vac input: EUM-200S105Mx				Measured at 100% load and steady-state temperature in 25°C ambient; (Efficiency will be about 2.0% lower if measured immediately after startup.)
Io= 700 mA	92.0%	94.0%	-	
Io=1050 mA	92.0%	94.0%	-	
EUM-200S150Mx				
Io=1050 mA	92.0%	94.0%	-	
Io=1500 mA	92.0%	94.0%	-	
EUM-200S280Mx				
Io=1800 mA	91.5%	93.5%	-	
Io=2800 mA	91.5%	93.5%	-	
EUM-200S560Mx				
Io=3500 mA	90.5%	92.5%	-	
Io=5600 mA	90.0%	92.0%	-	
Standby Power	-	-	0.5 W	Measured at 230Vac/50Hz; Dimming off
MTBF	-	205,000 Hours	-	Measured at 220Vac input, 80%load and 25°C ambient temperature (MIL-HDBK-217F)
Lifetime	-	102,000 Hours	-	Measured at 220Vac input, 80%load and 70°C case temperature; See lifetime vs. Tc curve for the details
Operating Case Temperature for Safety Tc_s	-40°C	-	+90°C	
Operating Case Temperature for Warranty Tc_w	-40°C	-	+80°C	Case temperature for 5 years warranty Humidity: 10% RH to 95% RH;
Storage Temperature	-40°C	-	+85°C	Humidity: 5%RH to 95%RH
Dimensions				With mounting ear
Inches (L × W × H)	6.73 × 2.66 × 1.44			7.40 × 2.66 × 1.44
Millimeters (L × W × H)	171 × 67.5 × 36.5			188 × 67.5 × 36.5

## General Specifications (Continued)

Parameter	Min.	Typ.	Max.	Notes
Net Weight	-	1000 g	-	

## Dimming Specifications

Parameter	Min.	Typ.	Max.	Notes	
Absolute Maximum Voltage on the Vdim (+) Pin	-20 V	-	20 V		
Source Current on Vdim (+)Pin	200 $\mu$ A	300 $\mu$ A	450 $\mu$ A	Vdim(+) = 0 V	
Dimming Output Range	EUM-200S105Mx EUM-200S150Mx EUM-200S280Mx EUM-200S560Mx	10%loset	-	loset	700 mA $\leq$ loiset $\leq$ 1050 mA 1050 mA $\leq$ loiset $\leq$ 1500 mA 1800 mA $\leq$ loiset $\leq$ 2800 mA 3500 mA $\leq$ loiset $\leq$ 5600 mA
	EUM-200S105Mx EUM-200S150Mx EUM-200S280Mx EUM-200S560Mx	70 mA 105 mA 180 mA 350 mA	-	loset	70 mA $\leq$ loiset < 700 mA 105 mA $\leq$ loiset < 1050 mA 180 mA $\leq$ loiset < 1800 mA 350 mA $\leq$ loiset < 3500 mA
Recommended Dimming Input Range	0 V	-	10 V	Default 0-10V dimming mode.	
Dim off Voltage	0.35 V	0.5 V	0.65 V		
Dim on Voltage	0.55 V	0.7 V	0.85 V		
Hysteresis	-	0.2 V	-		
PWM_in High Level	3 V	-	10 V	Dimming mode set to PWM in PC interface.	
PWM_in Low Level	-0.3 V	-	0.6 V		
PWM_in Frequency Range	200 Hz	-	3 KHz		
PWM_in Duty Cycle	1%	-	99%		
PWM Dimming off (Positive Logic)	3%	5%	8%		
PWM Dimming on (Positive Logic)	5%	7%	10%		
PWM Dimming off ( Negative Logic)	92%	95%	97%		
PWM Dimming on ( Negative Logic)	90%	93%	95%		
Hysteresis	-	2%	-		

## Safety & EMC Compliance

Safety Category	Standard
UL/CUL	UL8750,CAN/CSA-C22.2 No. 250.13
ENEC & CE	EN 61347-1, EN 61347-2-13

## Safety & EMC Compliance (Continued)

Safety Category	Standard
UKCA	BS EN 61347-1, BS EN 61347-2-13
CB	IEC 61347-1, IEC 61347-2-13
CCC	GB 19510.1, GB 19510.14
PSE	J 61347-1, J 61347-2-13
KS	KS C 7655
EAC	ГОСТ Р МЭК 61347-1, ГОСТ IEC 61347-2-13
EMI Standards	Notes
EN 55015/GB 17743/KN 15 <sup>(1)</sup>	Conducted emission Test & Radiated emission Test
EN 61000-3-2/GB 17625.1	Harmonic current emissions
EN 61000-3-3	Voltage fluctuations & flicker
FCC Part 15 <sup>(1)</sup>	ANSI C63.4 Class B
	This device complies with Part 15 of the FCC Rules. Operation is subject to the following two conditions: [1] this device may not cause harmful interference, and [2] this device must accept any interference received, including interference that may cause undesired operation.
EMS Standards	Notes
EN 61000-4-2	Electrostatic Discharge (ESD): 8 kV air discharge, 4 kV contact discharge
EN 61000-4-3	Radio-Frequency Electromagnetic Field Susceptibility Test-RS
EN 61000-4-4	Electrical Fast Transient / Burst-EFT
EN 61000-4-5	Surge Immunity Test: AC Power Line: Differential Mode 6 kV, Common Mode 10 kV
EN 61000-4-6	Conducted Radio Frequency Disturbances Test-CS
EN 61000-4-8	Power Frequency Magnetic Field Test
EN 61000-4-11	Voltage Dips
EN 61547	Electromagnetic Immunity Requirements Applies To Lighting Equipment

**Note:** (1) This LED driver meets the EMI specifications above, but EMI performance of a luminaire that contains it depends also on the other devices connected to the driver and on the fixture itself.

## Derating

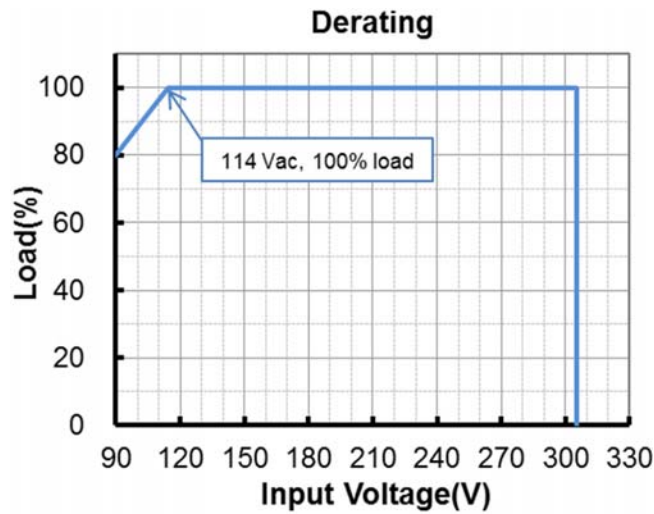

## Lifetime vs. Case Temperature

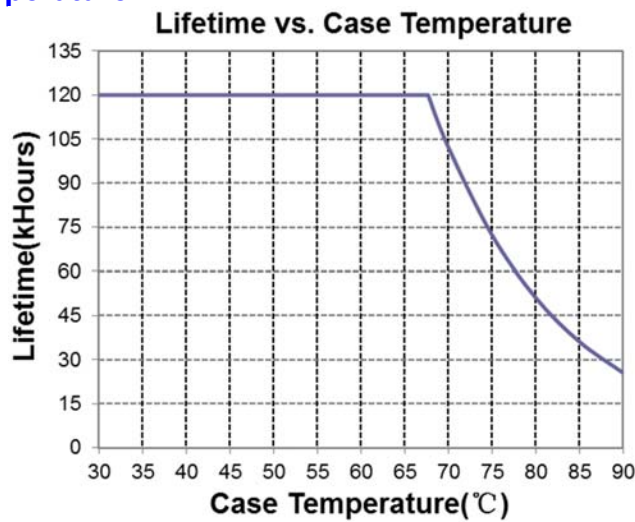

## Inrush Current Waveform

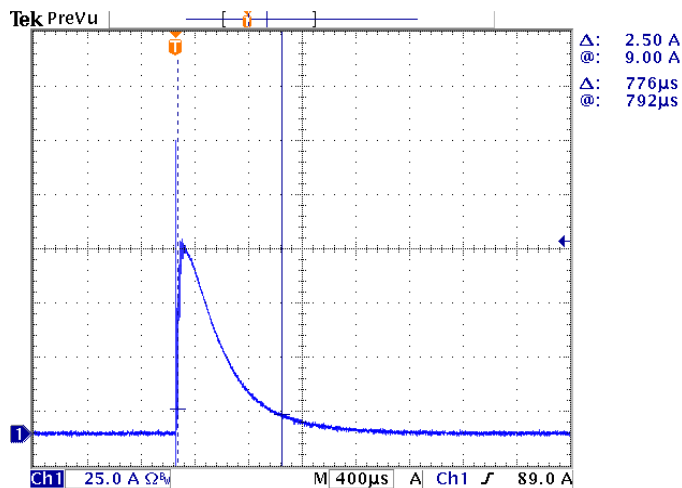



## Efficiency vs. Load

*EUM-200S105Mx* ( $I_o=700mA$ )  
Efficiency vs. Output Voltage

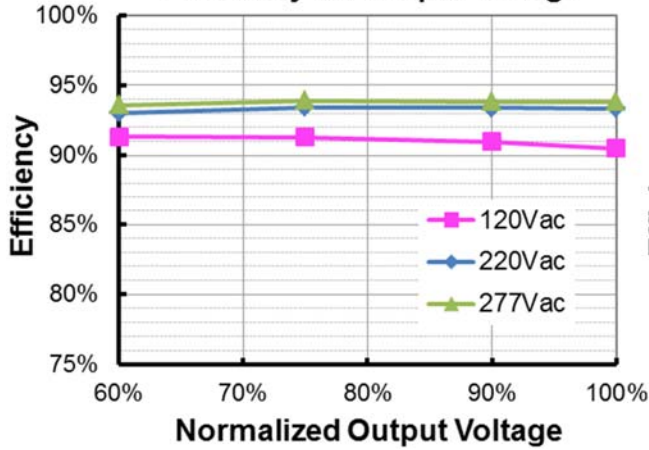

*EUM-200S105Mx* ( $I_o=1050mA$ )  
Efficiency vs. Output Voltage

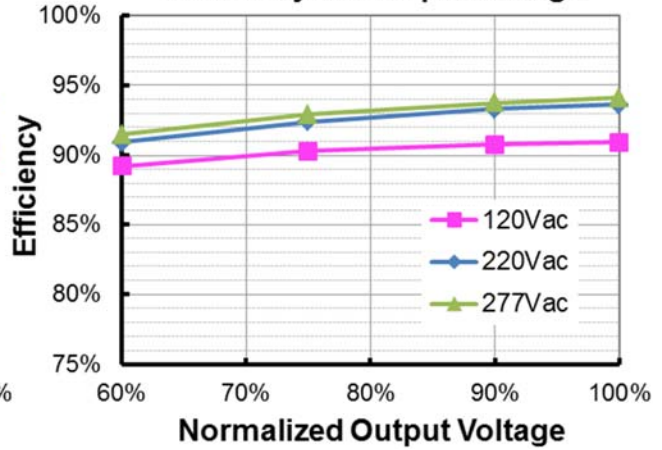

*EUM-200S150Mx* ( $I_o=1050mA$ )  
Efficiency vs. Output Voltage

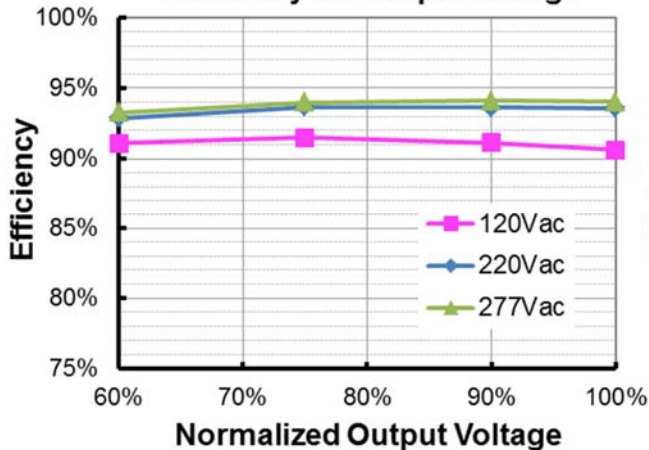

*EUM-200S150Mx* ( $I_o=1500mA$ )  
Efficiency vs. Output Voltage

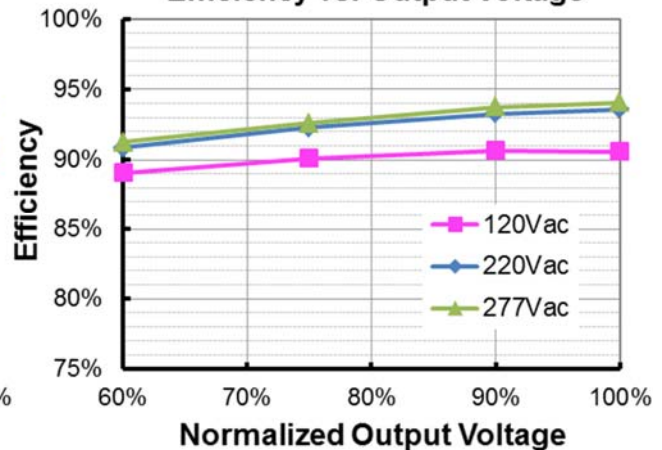

*EUM-200S280Mx* ( $I_o=1800mA$ )  
Efficiency vs. Output Voltage

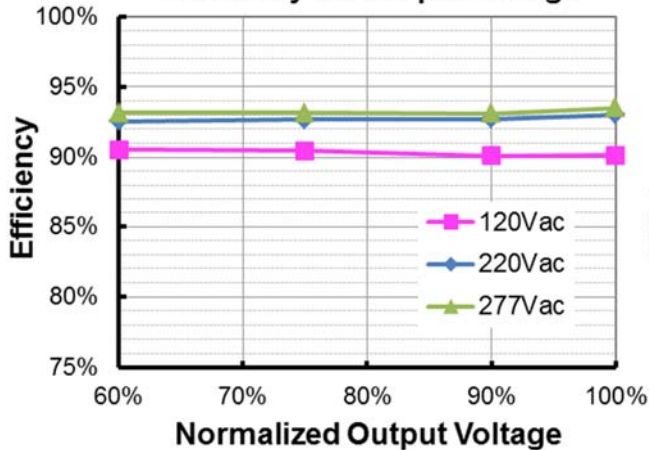

*EUM-200S280Mx* ( $I_o=2800mA$ )  
Efficiency vs. Output Voltage

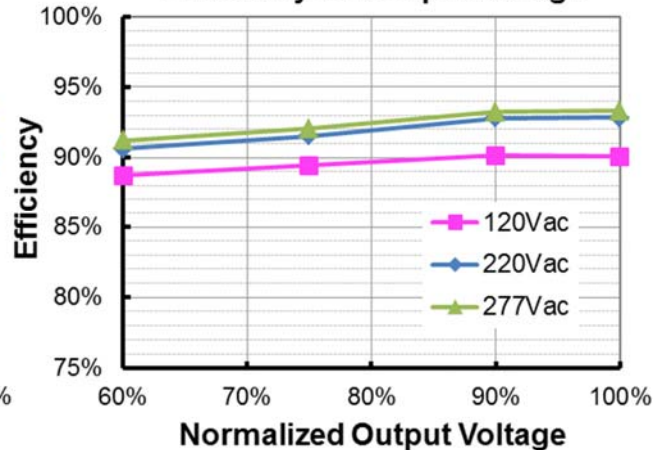



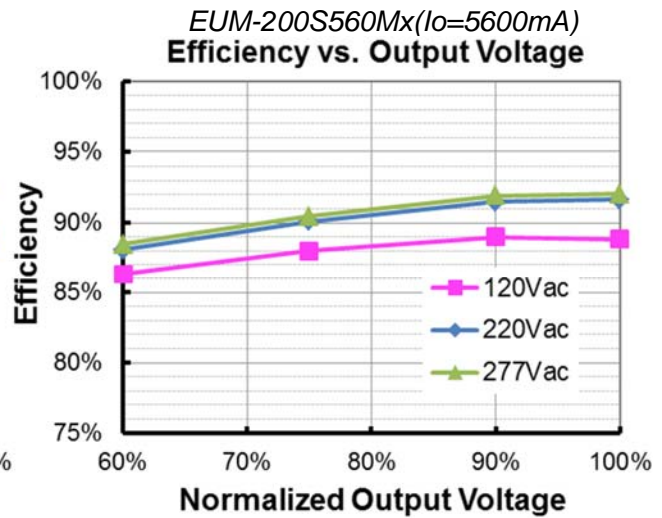
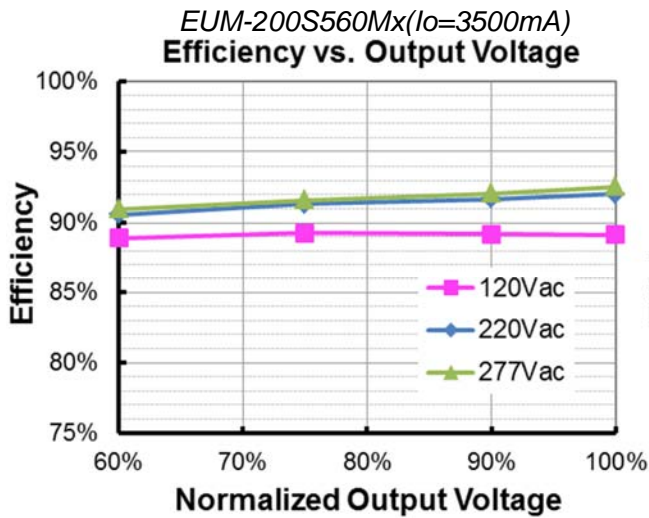

## Power Factor

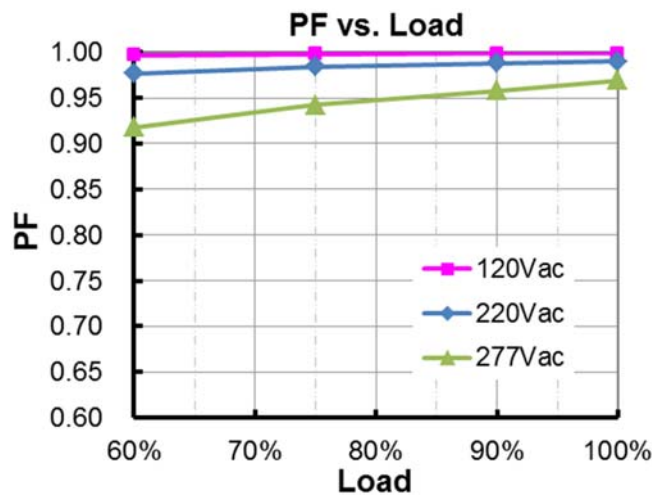

## Total Harmonic Distortion

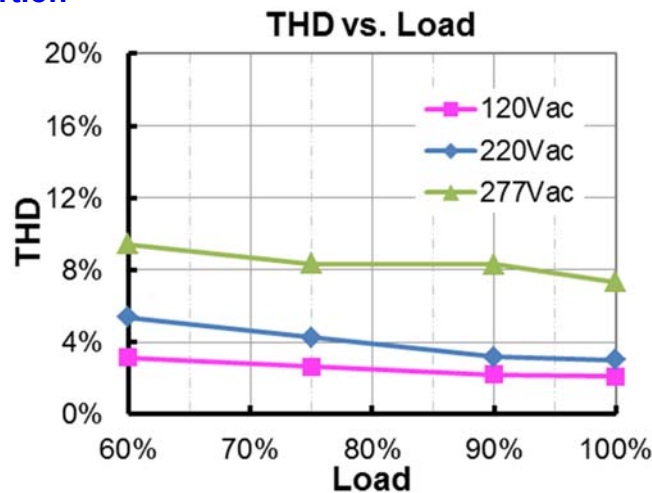

## Protection Functions

Parameter		Min.	Typ.	Max.	Notes
Over Voltage Protection		Limits output voltage at no load and in case the normal voltage limit fails.			
Short Circuit Protection		Auto Recovery. No damage will occur when any output is short circuited. The output shall return to normal when the fault condition is removed.			
Over Temperature Protection		Decreases output current, returning to normal after over temperature is removed.			
Input Under Voltage Protection (IUVP)	Input Under Voltage Protection	70 Vac	80 Vac	90 Vac	Turn off the output when the input voltage falls below protection voltage.
	Input Under Voltage Recovery	75 Vac	85 Vac	95 Vac	Auto Recovery. The driver will restart when the input voltage exceeds recovery voltage.
Input Over Voltage Protection (IOVP)	Input Over Voltage Protection	310 Vac	320 Vac	330 Vac	Turn off the output when the input voltage exceeds protection voltage.
	Input Over Voltage Recovery	300 Vac	310 Vac	320 Vac	Auto Recovery. The driver will restart when the input voltage falls below recovery voltage.
	Max. of Input Over Voltage	-	-	350 Vac	The driver can survive stabilized input over voltage conditions up to 350Vac for a total of 8 hours.

### ● Input Under Voltage Protection Diagram

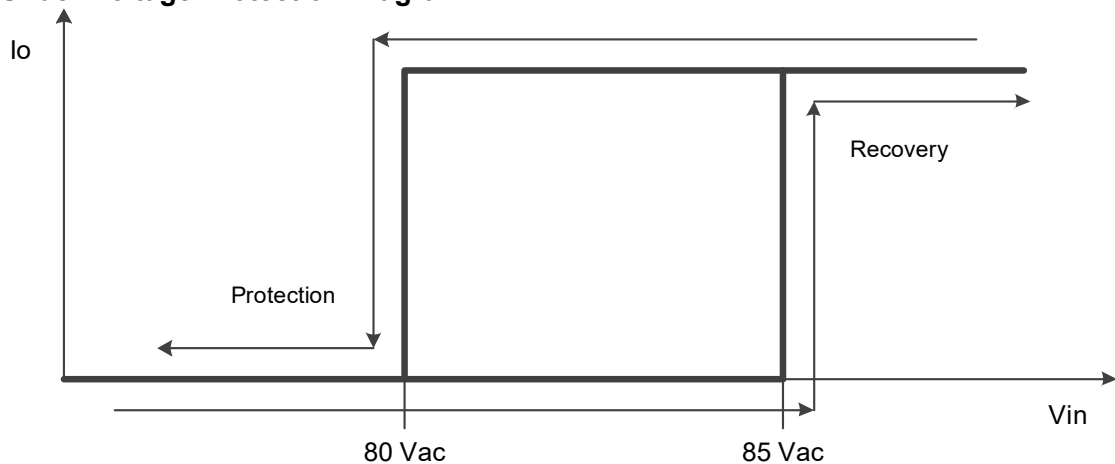

## ● Input Over Voltage Protection Diagram

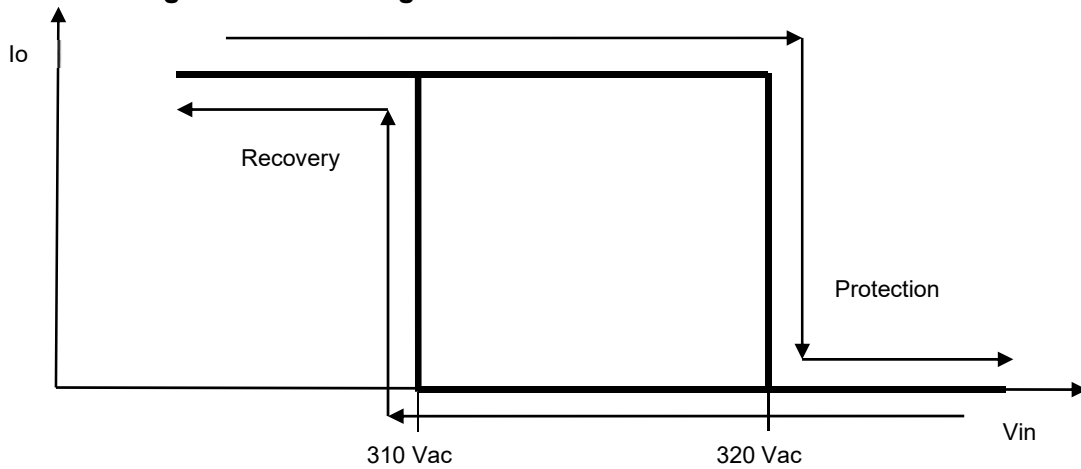

## Dimming

### ● 0-10V Dimming

The recommended implementation of the dimming control is provided below.

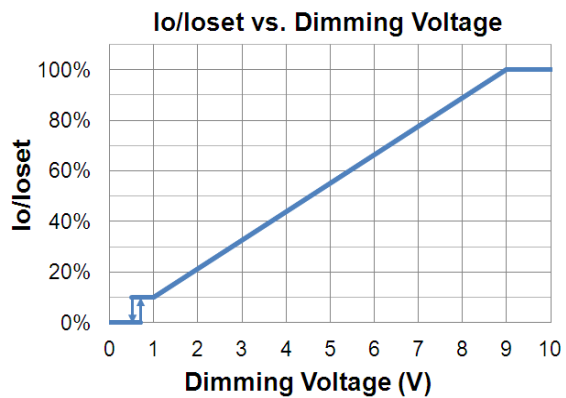
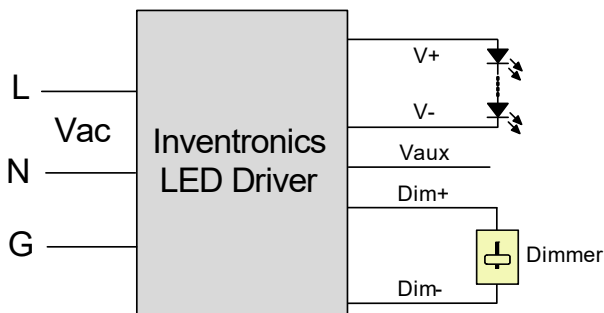

Implementation 1: Positive logic

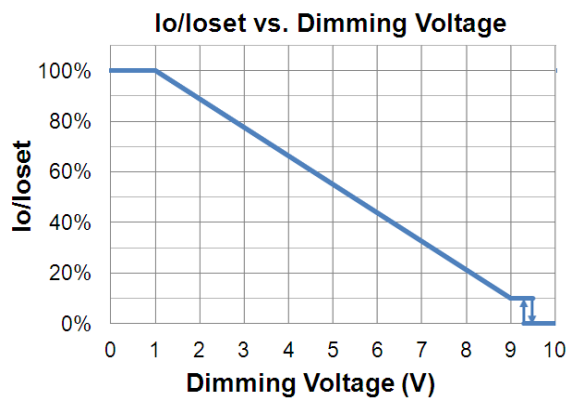
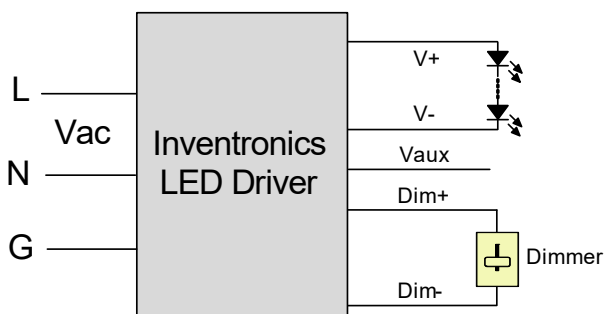

Implementation 2: Negative logic

### Notes:

1. Do NOT connect Dim- to the output V- or V+, otherwise the driver will not work properly.

- The dimmer can also be replaced by an active 0-10V voltage source signal or passive components like zener.
- When 0-10V negative logic dimming mode and Dim+ is open, the driver will dim to off and be standby..

## ● PWM Dimming

The recommended implementation of the dimming control is provided below.

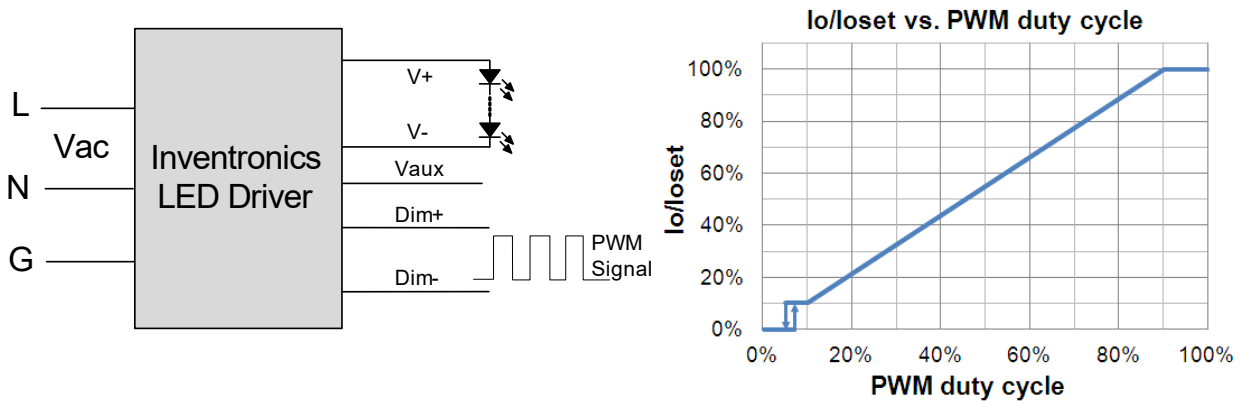

**Implementation 3: Positive logic**

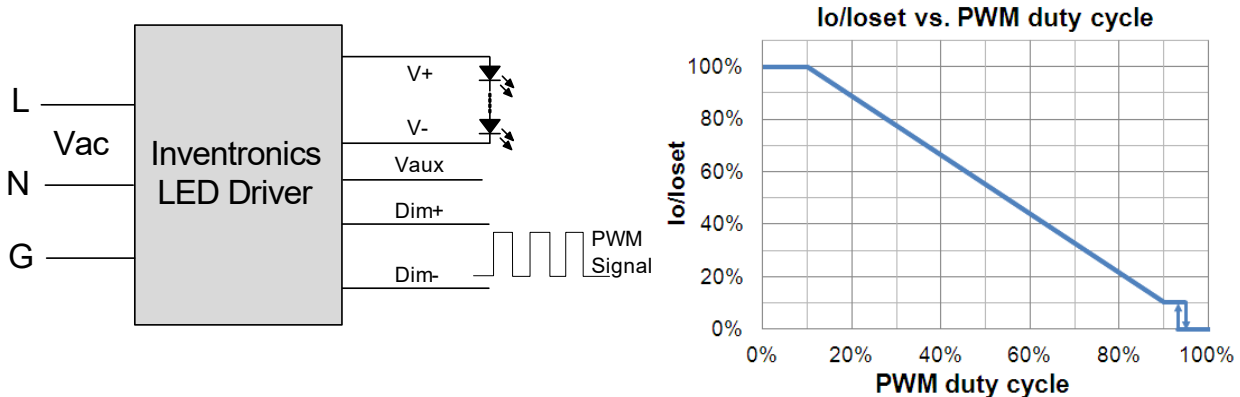

**Implementation 4: Negative logic**

### Notes:

- Do NOT connect Dim- to the output V- or V+, otherwise the driver will not work properly.
- When PWM negative logic dimming mode and Dim+ is open, the driver will dim to off and be standby.

## ● Time Dimming

Time dimming control includes 3 kinds of modes, they are Self Adapting-Midnight, Self Adapting-Percentage and Traditional Timer.

- Self Adapting-Midnight:** Automatically adjusts the dimming curve based on the on-time of past two days (if difference <15 minutes), assuming that the center point of the dimming curve is midnight local time.
- Self Adapting-Percentage:** Automatically adjusts the on-time of each step by a constant percentage = (actual on-time for the past 2 days if difference <15 min) / (programmed on-time from the dimming curve).
- Traditional Timer:** Follows the programmed timing curve after power on with no changes.

## ● Output Lumen Compensation

Output Lumen Compensation (OLC) may be used to maintain constant light output over the life of the LEDs by driving them at a reduced current when new, then gradually increasing the drive current over time to counteract LED lumen degradation.

● **End Of Life**

End-of-Life (EOL) is providing a visual notification to a user that the LED module has reached the end of manufacturer-specified life and that the replacement is recommended. Once active, an indication is given at each power-up of the driver, which the driver indicates this through a lower light output during the first 1 minute before normal operation is continued.

● **Digital Dimming**

Inventronics Digital Dimming is a UART (Universal Asynchronous Receive Transmitter) based communication protocol. Please refer to [Inventronics Digital Dimming](#) file for details.

## Programming Connection Diagram

EUM-200SxxxMG

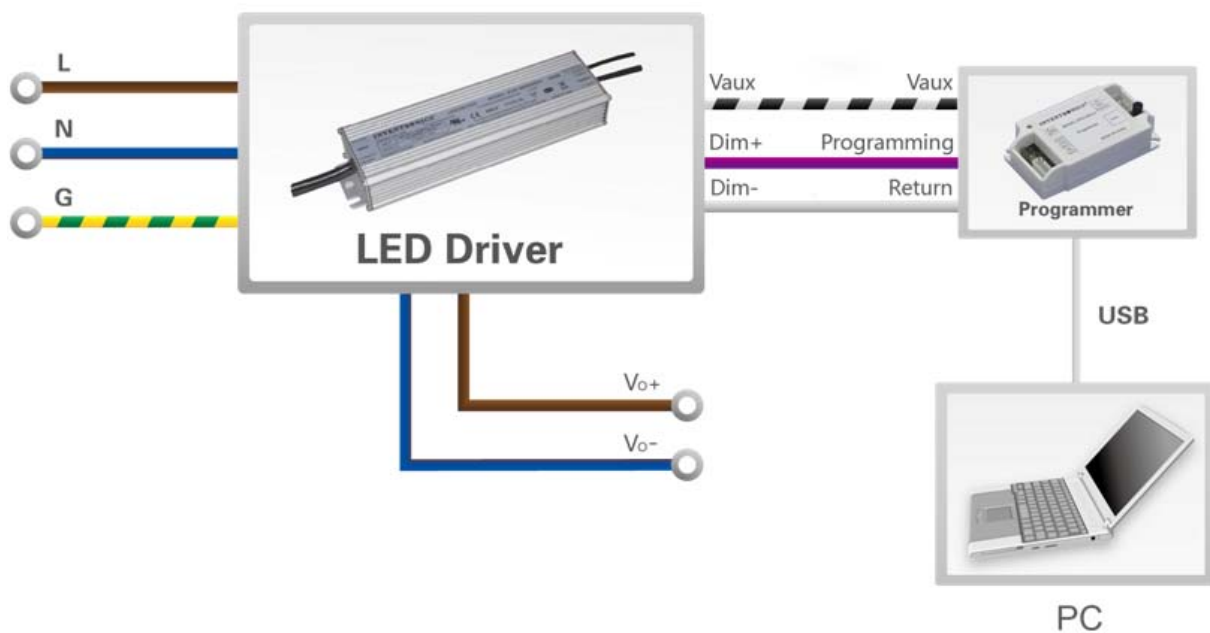

EUM-200SxxxMT

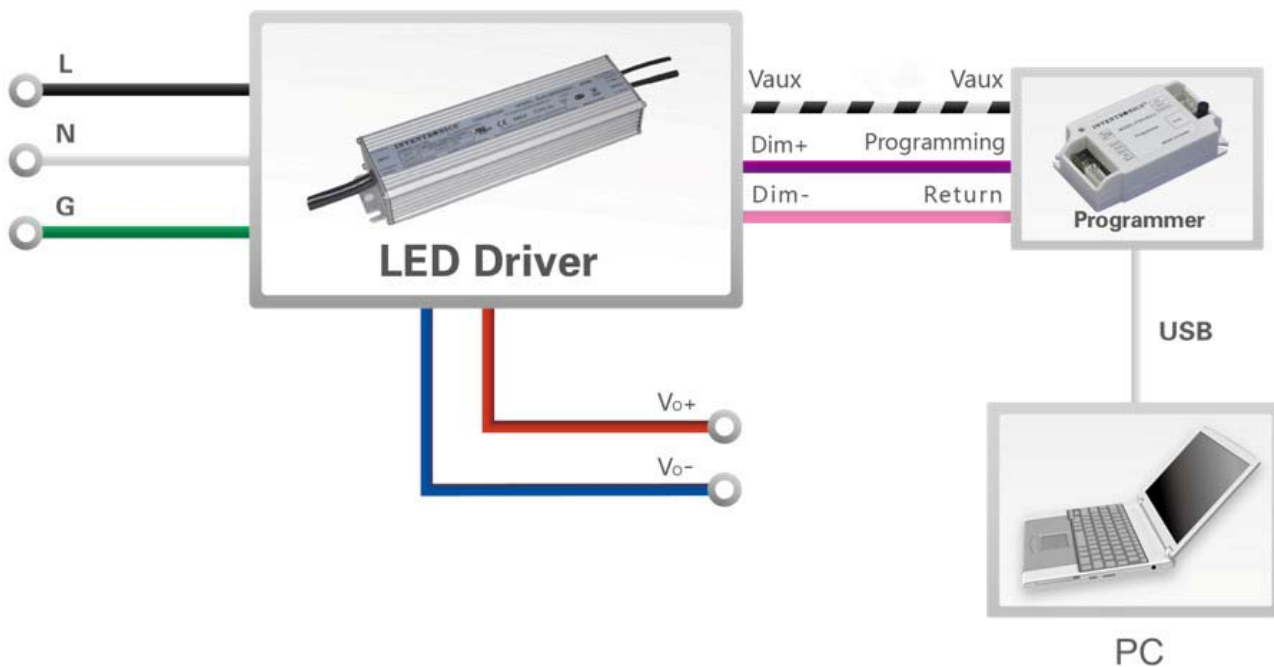

**Note:** The driver does not need to be powered on during the programming process.

- Please refer to [PRG-MUL2](#) (Programmer) datasheet for details.

## Mechanical Outline

EUM-200SxxxMG

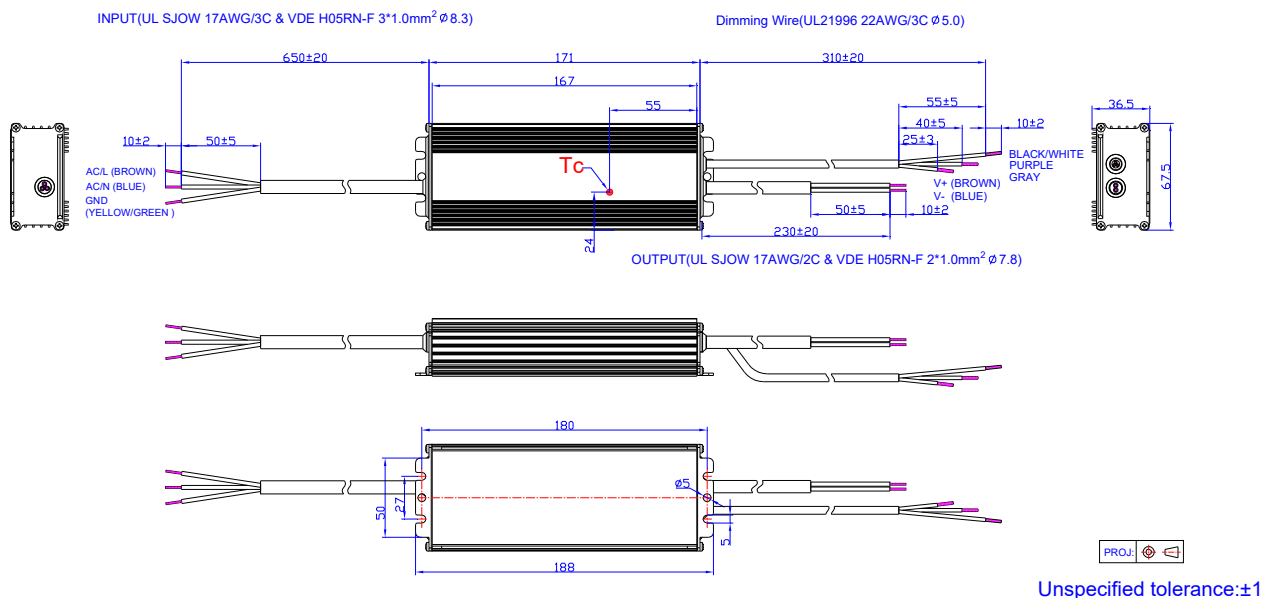



## EUM-200SxxxMT

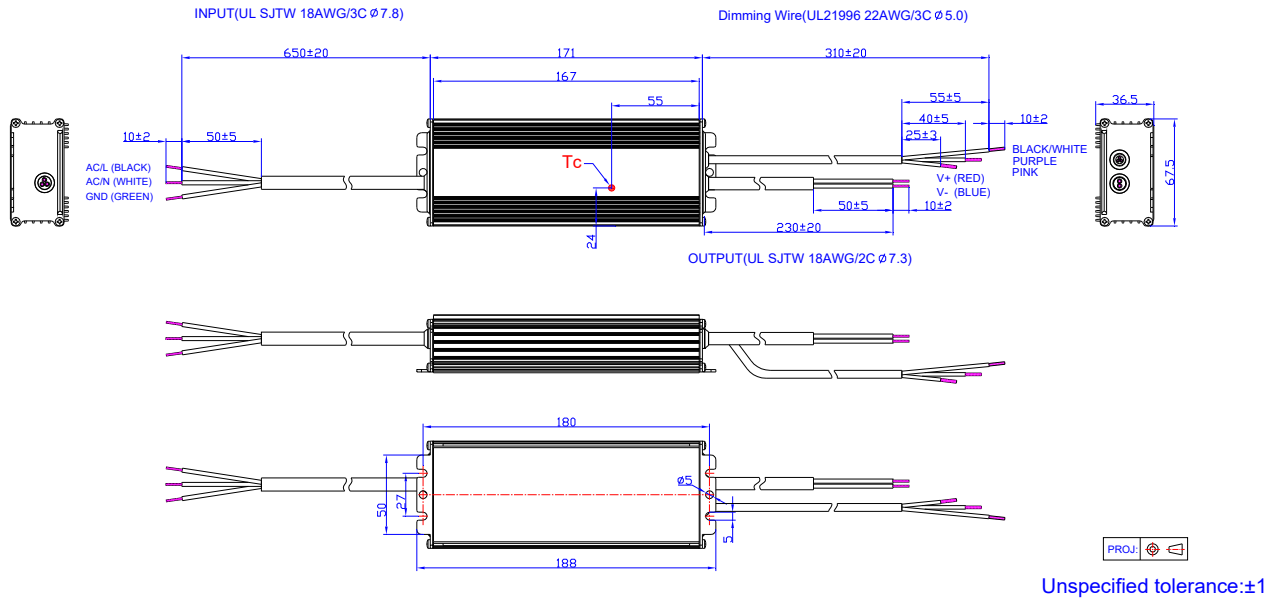

## RoHS Compliance

Our products comply with reference to RoHS Directive (EU) 2015/863 amending 2011/65/EU, calling for the elimination of lead and other hazardous substances from electronic products.

## Revision History

Change Date	Rev.	Description of Change		
		Item	From	To
2020-10-22	A	Datasheet Release	/	/
2021-10-28	B	UKCA logo	/	Added
		EAC logo	/	Added
		Safety & EMC Compliance	UKCA	Added
		Safety & EMC Compliance	EAC	Added
		Programming Connection Diagram	EUM-200SxxxMT	Updated
		Mechanical Outline	EUM-200SxxxMT	Updated